



**Probing Solutions.
Made in Germany.**

EN



FireFly[®]

**High Voltage Optically-Isolated Probe
with Universal BNC Interface**

>1.5 GHz, >180dB CMRR

Datasheet



About FireFly®

The FireFly® FF-1500A high voltage optically isolated probe offers industry leading performance that combines the ability to accurately resolve high bandwidth, small differential signals in the presence of large common mode voltages with its ultra-high common mode rejection performance across its entire bandwidth. With >1.5GHz bandwidth, wide differential input range, unmatched common mode rejection ratio CMRR up to >180dB (1 billion to 1 rejection), and a 60kV common mode, FireFly® is the ideal measurement solution for both GaN and SiC device characterization and system level design development.

PMK's optically isolated interface and unique compact angled probe head design are the key attributes that set FireFly® apart from the other solutions in the market, providing very stable and accurate measurements over a wide temperature range and easy access to the measurement points in tight spaces.

The compact angled probe head design allows for shorter tip cables to be used, resulting in higher signal fidelity measurements and reduced stresses placed on the measurement test point. FireFly®'s wide selection of probe tip connections and accessories offer reliable, hands-free, high-fidelity connectivity to the measurement points. Using industry standard MMCX and square pins connections allow FireFly® to easily interface to test boards that have already been designed with these test points.

FireFly® has a universal BNC output connector and is compatible with any oscilloscope with a 50Ω input impedance or 1MΩ input impedance and a 50Ω feed-through termination, allowing FireFly® to be used on any oscilloscope in the lab.

For accurate deskew, each probe's unique propagation delay is measured and added to each probe label.

The FireFly® probe head can be powered either with a power-over-fiber adapter for 24/7 continuous operation or by an easy to change, rechargeable, industry standard 18650 battery that provides continuous operation for up to 30h at room temperature. The interface box is powered in both cases by the required PMK power supply. The 2ch PS2 and 4ch PS3 power supplies all have remote control capabilities and therefore a USB interface and optional additional LAN interface. As an alternative for most flexible use, the 1 channel battery pack power supply AP-01 provides >8h of portable and isolated operation but has no software remote control.

FireFly® series has the capability to be controlled from either remote control or the controls located on the interface box.

For remote control PMK offers the software "PMK Probe Control" with graphical user interface, which is shipped with any PS2 and PS3 power supply, and is available for download at:

<http://www.pmk.de/en/products/probecontrol>

In addition, the Python package "PMK-probes" is available as a programming interface for controlling PMK's active probes. Installation instructions, examples and documentation can be found here:

<https://pmk-probes.readthedocs.io/en/latest/>

Factory Calibration

Annual re-calibration is recommended. ISO17025 calibration upon delivery or as re-calibration is possible on request.

Specifications

Read the Instruction Manual before first use and keep it for future reference. A digital copy of the latest Instruction Manual revision can be downloaded at www.pmk.de

Specifications that are marked with * are guaranteed, others are typical. Do not exceed specifications. Allow the probe to warm up for 20 minutes. The probe head and tip cables are not for handheld use. The probe can be used without the probe tip. To achieve the most accurate measurement results, review the "Getting Started" section in the Instruction Manual. This probe comes with 1 year warranty.

Electrical Specifications¹

Observe adequate spacing between probe head components and earth ground. This product is not rated for CAT II, III or IV. Do not exceed the specifications. Use original PMK power supplies only.

FireFly®	Bandwidth * (-3dB)	Rise time * (10% - 90%)	Input Attenuation	Input Impedance ²
SMA Input	> 1.5 GHz	<250 ps	1X	200 kΩ 5.1 pF
FF-MMCX-1V	> 1.5 GHz	<250 ps	1X	50 Ω ³
FF-MMCX-10V	> 1.3 GHz	<280 ps	10X	2 MΩ 3.4 pF
FF-MMCX-25V	> 1.3 GHz	<280 ps	25X	4.9 MΩ 2.1 pF
FF-MMCX-50V	> 1.3 GHz	<280 ps	50X	10 MΩ 2 pF
FF-MMCX-250V	> 1.3 GHz	<280 ps	250X	20 MΩ 2.1 pF
FF-WSQ-500V	> 1.0 GHz	<300 ps	500X	40 MΩ 2.8 pF
FF-WSQ-1000V	> 1.0 GHz	<300 ps	1000X	40 MΩ 2.9 pF
FF-WSQ-1500V	> 1.0 GHz	<300 ps	1500X	40 MΩ 2.7 pF
FF-WSQ-2500V	> 1.0 GHz	<300 ps	2500X	40 MΩ 2.5 pF

Maximum Rated Input Voltages ⁴

Common Mode Voltage ⁵ (Maximum Voltage to Earth)	± 60 kV (DC + Peak AC)	
No Measurement Category	Linear Input Voltage Range (DC + Peak AC) ²	Maximum Non-Destruct Differential Input Voltage (DC + Peak AC) ²
SMA Input	± 1 V	5 V
FF-MMCX-1V	± 1 V	5 V
FF-MMCX-10V	±10 V	50 V
FF-MMCX-25V	± 25 V	100 V
FF-MMCX-50V	± 50 V	100 V
FF-MMCX-250V	± 250 V	300 V
FF-WSQ-500V	± 500 V	3000 V **
FF-WSQ-1000V	± 1000 V	3000 V **
FF-WSQ-1500V	± 1500 V	3000 V **
FF-WSQ-2500V	± 2500 V	3000 V **
Pollution Degree	2	

See next page for more Electrical Specifications and footnotes.

Electrical Specifications (Continued)

Common Mode Rejection Ratio	DC	1 MHz	100 MHz	200 MHz	500 MHz	1 GHz
SMA Input	> 180 dB	165 dB	124 dB	122 dB	121 dB	118 dB
FF-MMCX-1V	> 180 dB	153 dB	113 dB	110 dB	109 dB	107 dB
FF-MMCX-10V	> 180 dB	144 dB	105 dB	100 dB	97 dB	95 dB
FF-MMCX-25V	> 180 dB	137 dB	91 dB	87 dB	86 dB	86 dB
FF-MMCX-50V	> 180 dB	132 dB	86 dB	83 dB	80 dB	81 dB
FF-MMCX-250V	> 180 dB	122 dB	75 dB	71 dB	69 dB	68 dB
FF-WSQ-500V	> 180 dB	101 dB	63 dB	60 dB	51 dB	49 dB
FF-WSQ-1000V	> 180 dB	94 dB	59 dB	56 dB	46 dB	42 dB
FF-WSQ-1500V	> 180 dB	91 dB	55 dB	51 dB	43 dB	35 dB
FF-WSQ-2500V	> 180 dB	89 dB	52 dB	45 dB	41 dB	32 dB
DC Gain Accuracy	< 2 % ± DC Offset voltage					
Noise (input referred)	SMA Input (1X): < 2 mV rms <i>With tip cable: (SMA Input noise) · (Tip cable input attenuation)⁷ scales proportionally to tip attenuation</i>					
DC Offset Voltage (input referred)	SMA Input (1X): < 1.5 mV (After Auto-Zero) <i>With tip cable: (SMA Input offset voltage) · (Tip cable input attenuation)⁸ scales proportionally to tip attenuation</i>					
Temperature Drift	< 0.05%/°C					
Propagation Delay	2 m fiber cable: 15 ns <i>The probe specific value is measured and printed on interface box label, tip cable approx. 500 ps</i>					
Battery Life	> 30 h @ 22 °C – 25 °C, > 20 h @ 0 °C, > 4 h @ 50 °C <i>Dependent on probe head operating temperature (Continuous Operation)</i>					
Output Termination & Coupling	50 Ω DC					
Battery Type	Protected 18650 Li-Ion, Rechargeable, 3.7V Certified					
Laser Certification	Laser Class 1 IEC/EN 60825-1:2014, US 21CFR Part 1010, US 21CFR Part 1040					

Notes:

* Guaranteed specification

¹ Determined when using a PS-02 power supply at +23°C ambient temperature.

² For input voltage and input impedance derating graphs review the FireFly® instruction manual.

³ Terminated, 50 Ω transmission line.

⁴ As defined in IEC 61010-1. Rated for indoor, dry location use only.

⁵ Galvanically isolated FireFly® probe head through fiber optic connection.

⁶ CMRR performance is >180dB below 100kHz. See CMRR graph.

⁷ Example: 10x tip FF-MMCX-10V noise = 10x SMA input noise.

⁸ Example: 10x tip FF-MMCX-10V offset = 10x SMA input offset.

Environmental Specifications

Parameter	Specification		
Temperature Range	Operating	Probe Head	0 °C to +50 °C
		Interface Box	0 °C to +40 °C
		Tip Cables & Adapters	-40 °C to +85 °C
	Non-Operating	Probe Head & Interface Box	-20 °C to +71 °C
Tip Cables & Adapters		-40 °C to +85 °C	
Maximum Relative Humidity	Operating	Probe Head	5 % to 85 % RH (relative humidity) at up to +40 °C, 5 % to 45 % RH above +40 °C up to +50 °C, non-condensing
		Interface Box	5 % to 85 % RH (relative humidity) at up to +40 °C, non-condensing
	Non-Operating	Tip Cables & Adapters	5% to 85% RH (relative humidity) at up to +85 °C, non-condensing
		Probe Head & Interface Box	5 % to 85 % RH (relative humidity) at up to +40° C, 5 % to 45 % RH above +40° C up to +71° C, non-condensing
Maximum Altitude	Operating		3000 m (9843 ft)
	Non-Operating		15000 m (49213 ft)

Physical Specifications

Parameter	Specification	
Weight	Probe	325 g
	Tip Cable	11 g
Length	Tip Cable	9.5 cm (3.74")
	Fiber Cable	2 m (6.56 ft)
Connectors	Probe	Input: SMA (Female) – Probe Head Output: BNC (Male) - Interface Box

Dimensions

The dimensions shown are in mm. Drawings from the probe tips are coming soon. If the needed drawing is missing, please contact us via sales@pmk.de

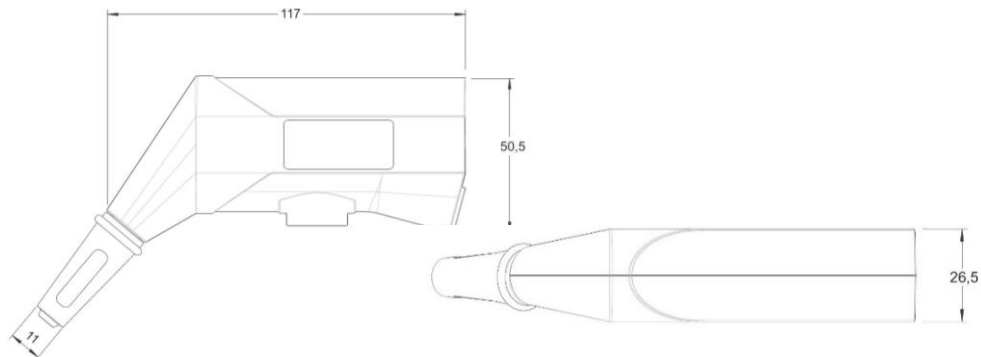

Typical Common Mode Rejection Ratio (CMRR)

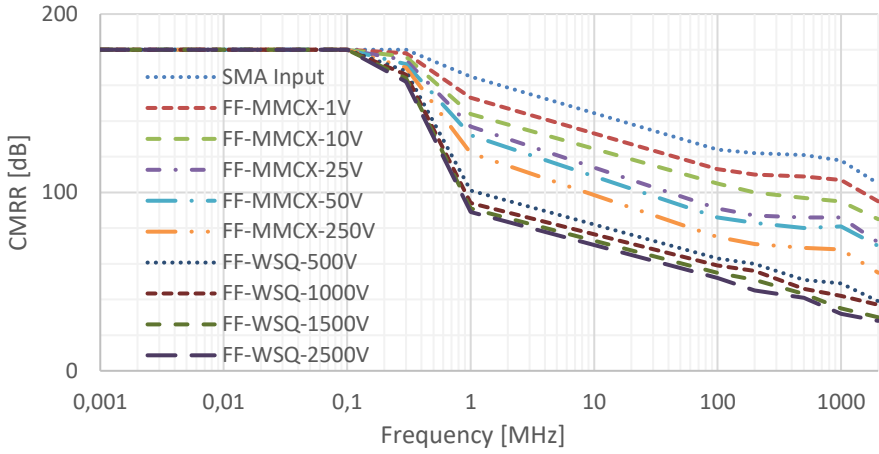

Typical Maximum Differential Input Voltage (CW)



Note that the maximum input voltage rating of the probe decreases as the frequency of the applied signal increases.

The maximum input voltage derating is coming soon.

Typical Frequency Response

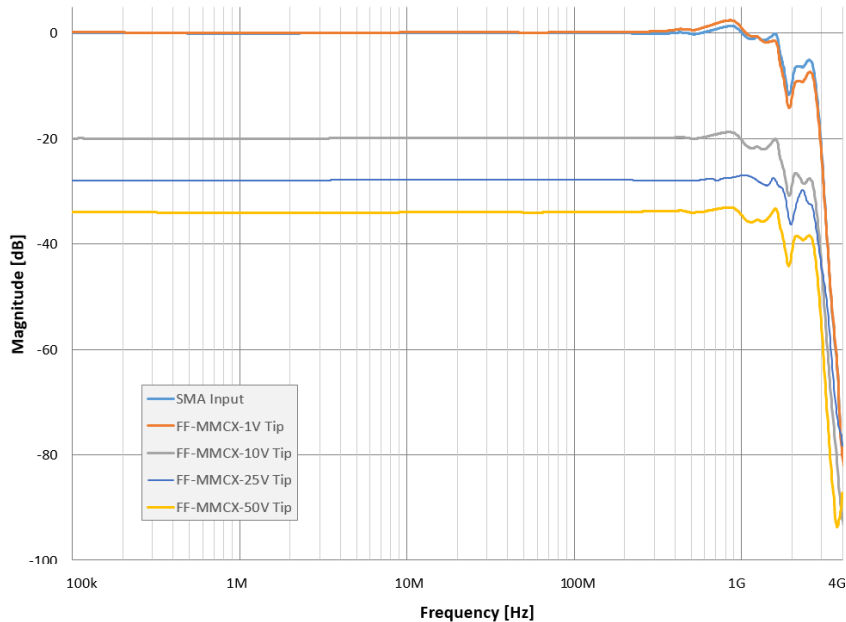

Typical Pulse Response

The graphs are normalized to 1 for better comparison.

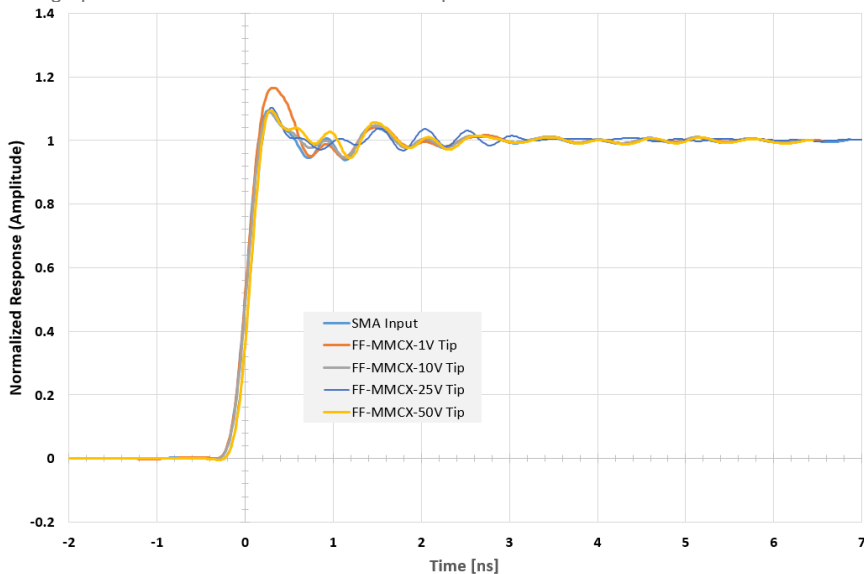

Typical Differential Input Impedance



Note that the maximum input voltage rating of the probe decreases as the frequency of the applied signal increases.

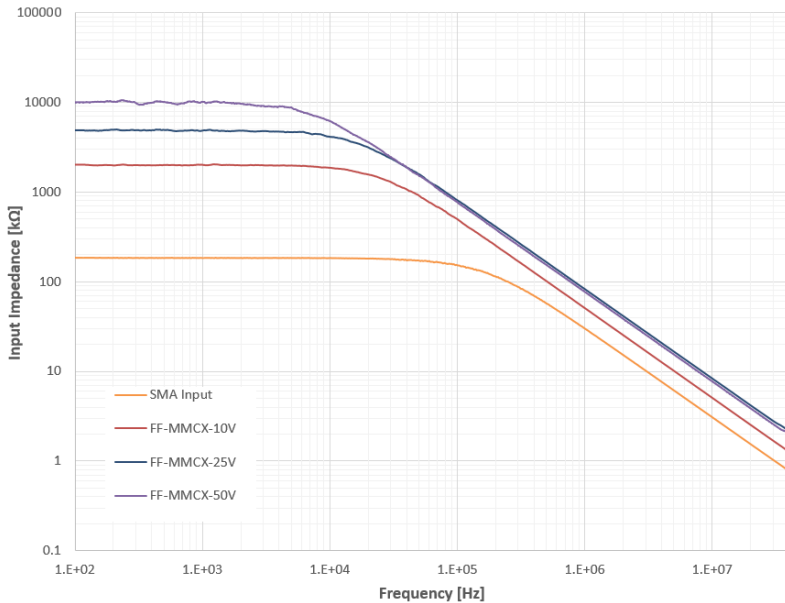

Connection to the Test Points (Circuit-Under-Test)

To achieve the best performance from the FireFly® probe, use an MMCX connector as close to the test point as possible. The MMCX connectors provide a compact footprint and solid metal body that provide the best signal fidelity of the signal being measured as well as shielding down as close as possible to the test point. This connection also provides a stable and repeatable measurement.

To achieve the best electrical performance, especially the CMRR performance and EMI susceptibility, place the probe tip adapter/accessories as close as possible to the circuit board.

To minimize the effects of common mode capacitive loading of the probe head/tip cable and maximum CMR, consider the following items.

- Whenever possible, connect the coaxial (common) shield of the tip cable to the test point that has the least dynamic signal, with respect to earth ground, relative to the tip cable signal (center) test point in the circuit-under-test.
- The coaxial (common) shield of the tip cable and tip cable adapters should always be connected to the lowest impedance point (usually a circuit common or power supply rail) in the circuit-under-test (relative to the tip cable/center conductor) to obtain the most accurate waveform.
- Increasing the physical distance between the probe head/tip cable and any conductive surface will reduce the parasitic capacitance.

Tips for Making Measurements with highest Signal Fidelity

- To achieve the best CMRR performance, make sure to tighten the tip cable to probe SMA connection.
- Measure as close as possible to the desired measurement point.
- Avoid fiber movement when making a precise measurement.
- If use a tip cable adapter/accessory with input leads, twist the input leads together to reduce the input inductance and improve the CMRR of the test setup.
- Add external ferrite beads over the tip cable or adapter/accessory as close as possible to the test points will improve the CMRR and common mode loading on the circuit-under-test.

CMRR Noise Suppression Kit

For use with probe tip cables to improve the overall common mode rejection ratio. Installing these ferrites onto FireFly® probe tip cable in use to improve the Common Mode Rejection Ratio (CMRR) and increase the Common Mode Impedance above 100MHz, typically. Up to a 20dB improvement to the Common Mode Rejection Ratio (CMRR) can be realized above 100MHz by installing these ferrites. For the best results, place the ferrites as close to the tip/measurement point as possible.

Scope of Delivery

Not all required items are included in the scope of delivery of the base probe FireFly® FF-1500A. See Ordering Information to configure your individual probing solution and select a required PMK power supply. The following is included in the scope of delivery.

- **FF-1500A** FireFly® base probe, $\pm 1V$ input range
- **890-520-900** Interface box probe connection cable (0.6m)
- **FF-2FOOTER** Probe head holder 2-Footer (Bi-Pod), strong magnetic holding force
- **891-102-CMRR** CMRR Noise Suppression Kit for Firefly®
- 2x 18650 rechargeable Lithium-Ion batteries
- USB Wall charger + USB cable (for battery charging) *Charger type may vary by region*
- Set cable coding rings (3x4 colors)
- Carrying case (black, plastic)
- Instruction Manual
- Safety Information



The accessories for this probe series have been safety tested. Do not use any other accessories, batteries or power supplies than what is recommended.

Ordering Information

Step 1: Select Probe Head

FF-1500A	FireFly® optical isolated probe, 1.5GHz, >180dB, 2m fiber cable (2 batteries and 2footer included, required power supply to be ordered separately)
FF-POF-A01	Power-Over-Fiber adapter for 24/7 continuous operation of the FireFly® probe head without using the 18650 battery at room temperature. One additional power supply channel is required. FF-1500A required.

Step 2: Select Probe Tip Cables

The probe tip cables are interchangeable without requiring any tools. The probe head SMA input range is $\pm 1V$ with no attenuation. Also review our new ultra-fast current shunt series UFCS on www.pmk.de.

FF-MMCX-1V	FireFly® probe tip cable, MMCX, $\pm 1V$, >1.5GHz, 1x attenuation, 50 Ω terminated for shunt measurements
FF-MMCX-10V	FireFly® probe tip cable, MMCX, $\pm 10V$, >1.3GHz, 10x attenuation
FF-MMCX-25V	FireFly® probe tip cable, MMCX, $\pm 25V$, >1.3GHz, 25x attenuation
FF-MMCX-50V	FireFly® probe tip cable, MMCX, $\pm 50V$, >1.3GHz, 50x attenuation
FF-MMCX-250V	FireFly® probe tip cable, MMCX, $\pm 250V$, >1.3GHz, 250x attenuation
FF-WSQ-500V	FireFly® probe tip cable for 5.08mm square pins, $\pm 500V$, >1.0GHz, 500x attenuation
FF-WSQ-1000V	FireFly® probe tip cable for 5.08mm square pins, $\pm 1kV$, >1.0GHz, 1000x attenuation
FF-WSQ-1500V	FireFly® probe tip cable for 5.08mm square pins, $\pm 1.5kV$, >1.0GHz, 1500x attenuation
FF-WSQ-2500V	FireFly® probe tip cable for 5.08mm square pins, $\pm 2.5kV$, >1.0GHz, 2500x attenuation

Step 3: Select Connectivity Accessories

Observe the frequency derating of each accessory. Observe maximum input voltage of the probe's input. Do not use any other accessories.

FF-SQ-MMCX5

5x MMCX to 2x 0.025" (0.635mm) socket, -40°C to +125°C



FF-HTSPAD-MMCX3

3x MMCX solder-in cable adapter HT, 50Ω RF micro coax to flex solder-in pad, -40°C to +155°C (green = 0Ω, yellow = 36Ω, red = 75Ω)



FF-HTS-MMCX2

2x MMCX solder-in cable adapter HT, MMCX socket with 50Ω RF micro coax cable and open end, -40°C to +155°C



FF-UFL-MMCX2

2x MMCX cable adapter, MMCX socket with 50Ω RF micro coax cable to UFL socket, -40°C to +125°C



FF-2XR-MMCX

MMCX to 2x XR Mini-Hook



FF-WSQ-4mm-2

2x extension lead for FireFly® HV tips (5.08mm pitch) to 2x 4mm safety banana plugs (male), e.g. to use BumbleBee® series accessories



FF-WSQ-SPADE-2

2x extension lead for FireFly® HV tips (5.08mm pitch) to spades (Ø4mm opening)



FF-MMCX-SPADE-3

3x extension lead for FireFly® MMCX tips to spades (Ø4mm opening)



972416100 2-pole test clip SMD for use with FF-SQ-MMCX5



P25-2 Pico Hook™ red for use with FF-SQ-MMCX5



P25-0 Pico Hook™ black for use with FF-SQ-MMCX5









D010031 50Ω BNC feed-through for 1MΩ input oscilloscopes





Step 4: Select Shunt for Current Measurements

Each resistance model is available as single pack or as more cost-effective packs of 10 or 25 pieces. An input tip cable with 50Ω termination, e.g. FF-MMCX-1V, is required for use with these shunts. The Shunts have a 50Ω female SMA output, so an SMA to MMCX adapter is needed as well.

UFCS-R001	1mΩ, bandwidth TBD, <200pH insertion inductance, TBD A maximum pulse current, SMA (F) output, 1pc. Also available as packs: 10pcs UFCS-R001x10 , 25pcs UFCS-R001x25	
UFCS-R005	5mΩ, >800MHz bandwidth, <200pH insertion inductance, TBD A maximum pulse current, SMA (F) output, 1pc. Also available as packs: 10pcs UFCS-R005x10 , 25pcs UFCS-R005x25	
UFCS-R011	11mΩ, >1GHz bandwidth, <200pH insertion inductance, 104A maximum pulse current @ 100μs, SMA (F) output, 1pc Also available as packs: 10pcs UFCS-R011x10 , 25pcs UFCS-R011x25	
UFCS-R024	24mΩ, >1GHz bandwidth, <200pH insertion inductance, 70A maximum pulse current @ 100μs, SMA (F) output, 1pc Also available as packs: 10pcs UFCS-R024x10 , 25pcs UFCS-R024x25	
UFCS-R052	52mΩ, >900MHz bandwidth, <200pH insertion inductance, 48A maximum pulse current @ 100μs, SMA (F) output, 1pc Also available as packs: 10pcs UFCS-R052x10 , 25pcs UFCS-R052x25	
018-291-970	Adapter for use of UFCS series shunts with FireFly® series. SMA plug to MMCX socket, 50Ω	

Step 5: Select Positioning System

FF-3DPOS200A	FireFly® 3D Probe Positioner for 10kV Insulation with steel base (893-100-001), arm with span width 200mm (893-200-200), FireFly® non-conducting probe holder (FF-HAL10kV-A), Wrench 7mm, strong magnetic holding force	
FF-HAL10kV-A3	FireFly® non-conducting probe holder, max 10kV for use with PMK's 3D Probe Positioning Systems and SKID Probes and PCB Board holder systems, strong magnetic holding force, pack of 3 – spare parts	
FF-2FOOTER	FireFly® positioner 2-Footer (Bipod), non-conducting, strong magnetic holding force - included in probe's scope of delivery	

Step 6: Select Power Supply

A PMK power supply PS2 or PS3 is required for using the probe, also when powering the probe head with the optional Power-over-Fiber adapter FF-POF-A01 instead of an 18650 battery.



The power supply pin assignment is different from other power supplies. Use only original PMK power supplies with PMK probes.

889-09V-PS2	PS-02 (2 channels, with USB interface for remote control)
889-09V-PS2-L	PS-02-L (2 channels, with LAN and USB interface for remote control)
889-09V-PS3	PS-03 (4 channels, with USB interface for remote control)
889-09V-PS3-L	PS-03-L (4 channels, with LAN and USB interface for remote control)
889-09V-AP01	AP-01 (battery pack, 1 channel, no remote control)
890-520-900	Power supply cable (0.6 m), included in probe's scope of delivery
890-520-915	Power supply cable (1.5 m)

Observe Connector Pin-Out
for PMK power supply cables



Step 7: Select Accredited Calibration

KAL-DAKKS-FF	ISO 17025 (re-)calibration
---------------------	----------------------------

Step 8: Select Additional Accessories

D010031	50Ω BNC feedthrough for use with 1MΩ oscilloscope inputs, 0.5W
----------------	--

Coming Soon / In Development

New connectivity solutions

If you need any non-published accessory, please contact us via sales@pmk.de

Copyright © 2025 PMK - All rights reserved.

Information in this publication supersedes that in all previously published material.
Specifications are subject to change without notice.

Informationen in dieser Anleitung ersetzen die in allen bisher veröffentlichten Dokumenten.
Änderungen der Spezifikationen vorbehalten.